

NEO 500 SINGLE SIDED WITH NEO 500 AUTOMATIC BEV[®] BURNER

Net Zero fireplace with BEV Technology[®]



AUTOMATIC BEV[®] BURNER

The BEV Technology[®] guarantees burning that is free of smoke, odor, or ash. This technology creates a flame by burning ethanol vapors, ensuring that the fire has no direct contact with the liquid fuel.



AUTOMATIC REFILLING

The automatic pump communicates with the device, delivering the necessary amount of fuel. There is no risk of overfilling the tank or spilling the fuel.



DETACHABLE SIDE PANELS

Your Neo Fireplace comes with two detachable side panels. You decide what shape it will take - Single-Sided, Left Corner, Right Corner or Three-Sided.



REMOTE CONTROL

Easily control your fireplace with the handy remote. You're in charge of the flames. Go for one of 2 flame levels to adjust the ambience and coziness to your needs.



ZERO CLEARANCE FIREBOX

The ultimate firebox with our zero clearance design allows you to seamlessly integrate the fireplace into combustible materials and mount your TV directly above the fireplace.



DECORATIVE LOGS

Neo gives you the freedom to choose between a cozy, traditional look with decorative logs or a sleek, modern aesthetic—just remove the log tray to transform the style in seconds.

Neo 500 Single Sided

Fuel tank capacity	1.3 L 0.34 gal
Maximum burn time	4.0 hours
Maximum heat output	4.1 kW 13 990 BTUs/h
Minimum room cubature	41 m ³ 1448 ft ³
Flame height regulation	2 stages
Fuel type	bioethanol 95 - 96,6%
Flue	not required
Air change rate	1 space volume per hour
Power supply	230 V 115 V
Finish	black powder coating
Materials	steel, galvanized steel, tempered glass
Application	for indoor use only

CONTROL OPTIONS



included

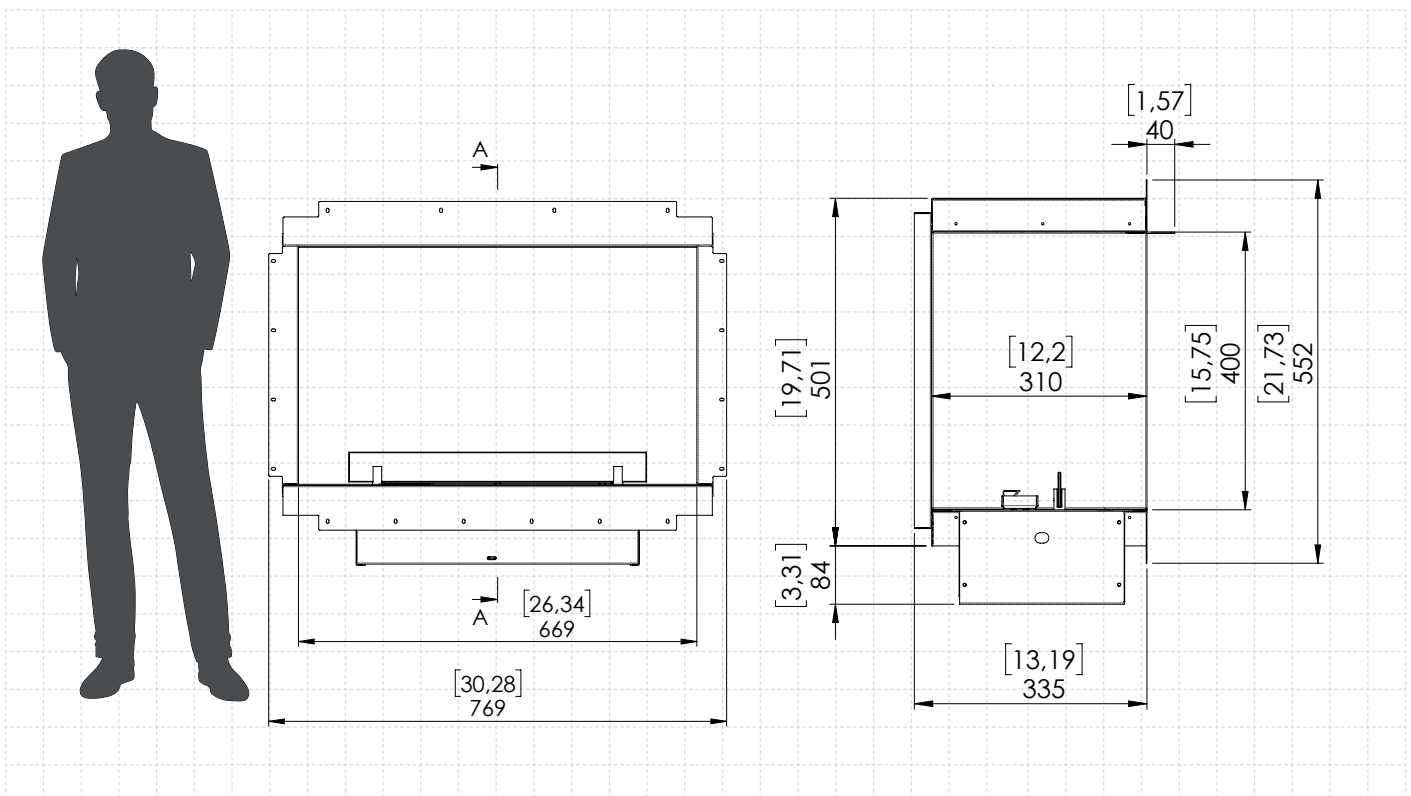

All product specifications and data are subject to change without notice and are believed to be accurate as of the date hereof. Planika Sp. z o.o., its affiliates, agents, and employees, and all persons acting on its or their behalf (collectively, "Planika Sp. z o.o."), disclaim any and all liability for any errors, inaccuracies or incompleteness contained in any document or in any other disclosure relating to any product. To the maximum extent permitted by applicable law, Planika Sp. z o.o. disclaims any and all liability arising out of the application or use of any product. No license, express or implied, by estoppel or otherwise, to any intellectual property rights is granted by this document or by any conduct of Planika Sp. z o.o.. Customers using or selling Planika Sp. z o.o.'s products not expressly indicated for use in such applications do so entirely at their own risk and agree to fully indemnify Planika Sp. z o.o. for any damages arising or resulting from such use or sale. The provided fuel consumption is based on laboratory testing on the lowest flame level. The actual consumption of individual devices may vary. The images are indicative only.